

# Fan Filter Unit



# Fan Filter Unit Features

## Advantaged designs

- High quality, efficient & low noise level motor with external rotor type backward curved centrifugal fan.
- Room-Side Replaceable filters (RSR) designs minimize downtime and make quick filter changes available.
- Low profile casing designs to save more space.

## Various design options

- Casing material: Galvalume / SUS / Aluminium.
- Available in standard and custom sizes.
- Available in standard and special designs for various applications.

## Uniformity of air distribution

- Guarantees the uniformity deviation of air velocity on FFU surface is under  $\pm 15\%$ .

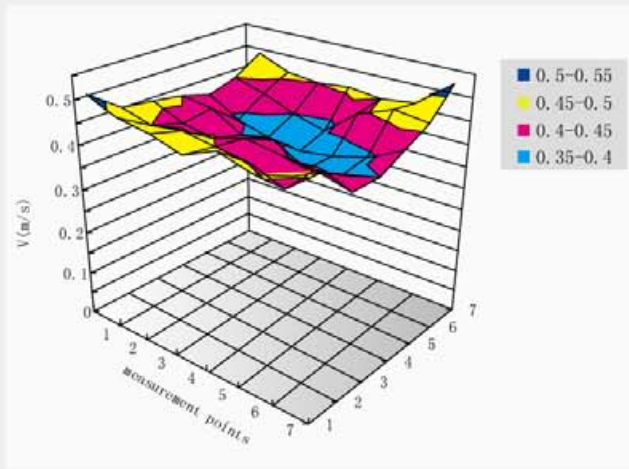

Notes: Air velocity with the filter in 42 square sections of same size below the filter.

## CE/UL certification

- UL Listed and CE Marked units available.

## Various optional accessories

- Pre-filter, diffuser, stepless/5 step controller, RSR frame, pressure gauge, indicator (run/trip) etc.

## Noise measurement

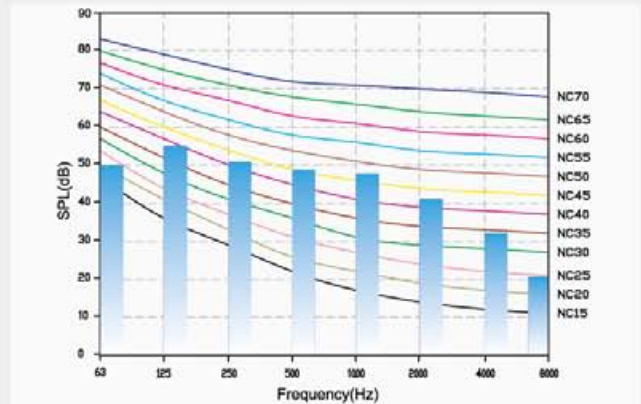

Low noise: Special sound measuring facilities make it possible to detect every peak in frequency bands and to improve a spectrum by designing new noise patterns.

## Group control management systems

- Remote control and centralised management can be performed by EC or AC systems.
- System operating conditions can be fully controlled remotely.

## Air flow simulation

- Air flow simulation optimizes FFU casing structure to achieve low noise, high total static pressure and high efficiency.

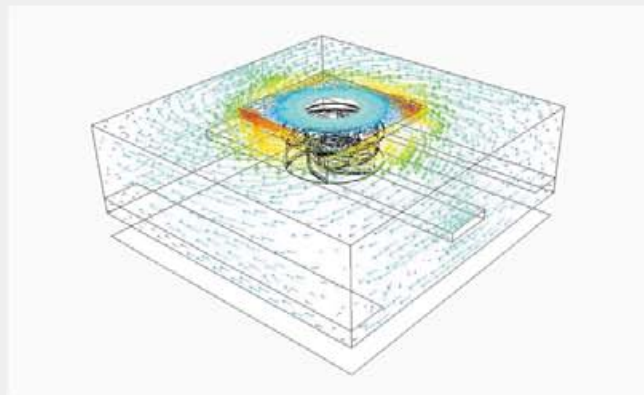

Notes: MayAir uses professional computational fluid dynamics software to do simulation.

# Fan Filter Unit Specifications

## AC motor Power: 1 $\phi$ 220-240V 50Hz

Model	F-22AL	F-23AL	F-24AL	F-24AM
W x L(mm)	600x600/ 575x575	600x900/ 575x875	600x1200/ 575x1175	
H(mm)	250	250	250	275
Air volume(m <sup>3</sup> /h)	530	800	1100	1100
Max TSP(Pa)	230	200	180	260
Power Consumption(W)	105	120	145	150
Noise Level(dBA)	50	51	52	53
Vibration Level(mm/s)	0.7	0.8	1.2	1.2

Model	F-34AM	F-34AM1	F-44AM1	F-44AH
W x L(mm)	900x1200/ 875x1175		1200x1200/ 1175x1175	
H(mm)	275	275	315	350
Air volume(m <sup>3</sup> /h)	1650	1650	2200	2200
Max TSP(Pa)	190	260	180	230
Power Consumption(W)	210	240	275	310
Noise Level(dBA)	53	53	55	55
Vibration Level(mm/s)	1.2	1.2	1.3	1.4

## EC motor Power: 1 $\phi$ 200-277V 50Hz

Model	F-22EL	F-23EL	F-24EL	F-24EM
W x L(mm)	600x600/ 575x575	600x900/ 575x875	600x1200/ 575x1175	
H(mm)	250	250	250	275
Air volume(m <sup>3</sup> /h)	530	800	1100	1100
Max TSP(Pa)	270	240	180	370
Power Consumption(W)	65	85	105	100
Noise Level(dBA)	50	51	52	53
Vibration Level(mm/s)	0.7	0.8	1.2	1.2

Model	F-34EM	F-34EH	F-44EM	F-44EH
W x L(mm)	900x1200/ 875x1175		1200x1200/ 1175x1175	
H(mm)	275	275	275	350
Air volume(m <sup>3</sup> /h)	1650	1650	2200	2200
Max TSP(Pa)	290	400	190	310
Power Consumption(W)	150	160	230	230
Noise Level(dBA)	53	54	54	54
Vibration Level(mm/s)	1.2	1.2	1.3	1.4

### Notes:

- Air volume in above tables is at 0.45m/s air velocity.
- Parameters are based on standard operating point.
- Power Consumption is at TSP 170Pa operating point.
- Test point of noise is 1.5m below the air outlet surface centre of filter.
- These FFUs are available in standard and custom sizes.
- TSP=Total Static Pressure.

# Fan Filter Unit Performance Curves

## F-24AM

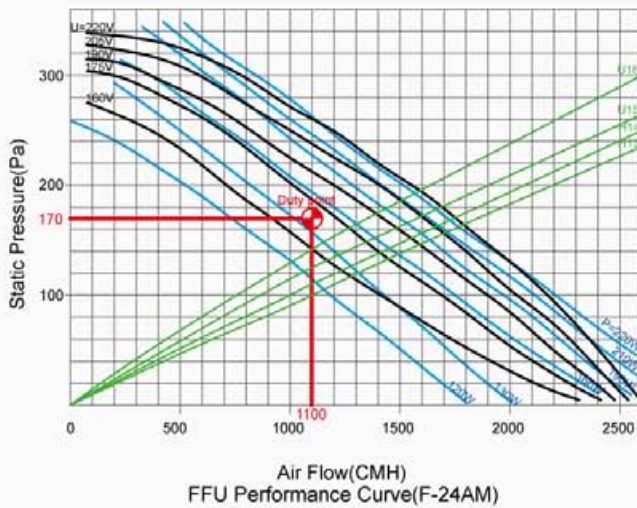

## F-24EM

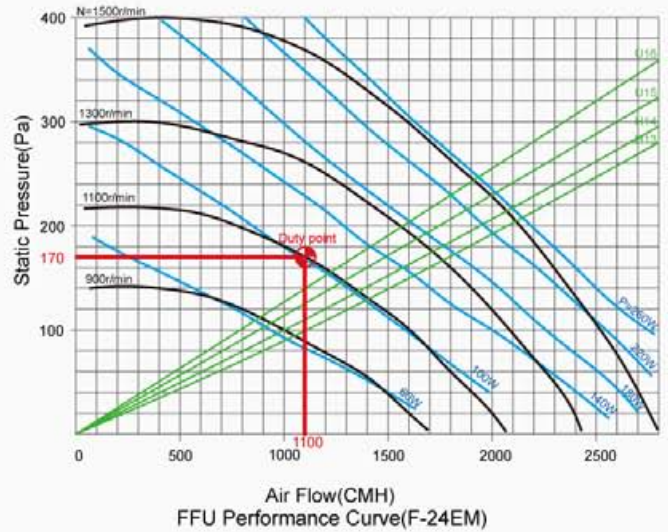

## F-44AH

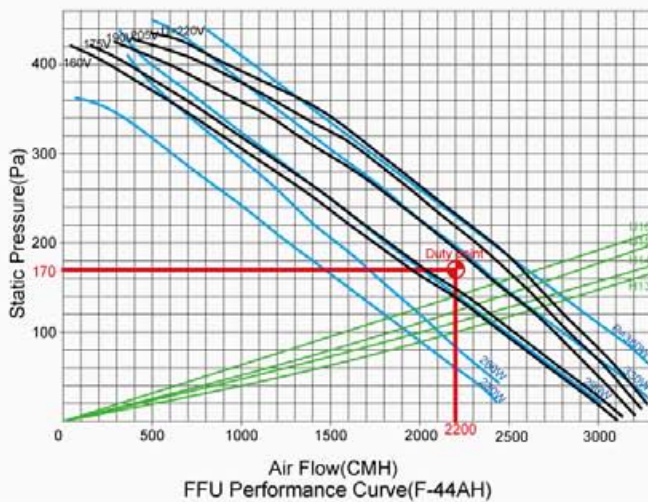

## F-44EH

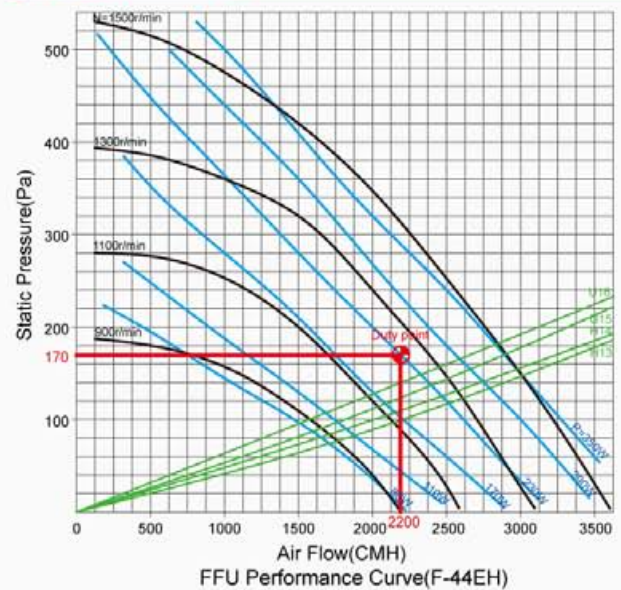

— Air volume— Total static pressure curve  
 — Air volume— Power consumption curve

— Air volume— Initial resistance curve of HEPA/ULPA filter(Thickness: 70mm)

# Fan Filter Unit Drawings And Accessories

**F-24 Top Elevation**

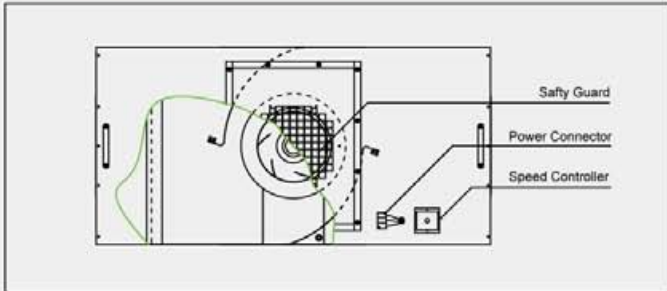

**F-24 Lateral Elevation**

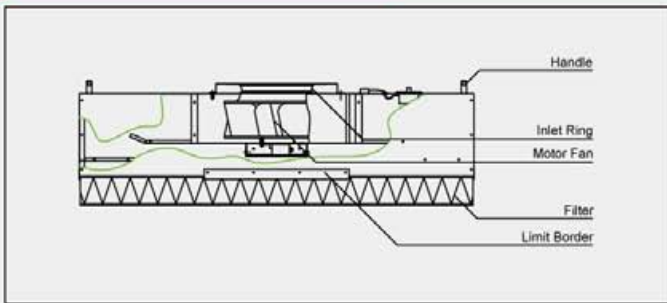

**Gasket Filters Type**

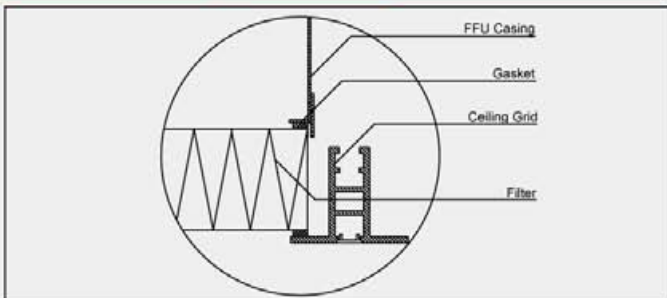

**RSR Filters Type**

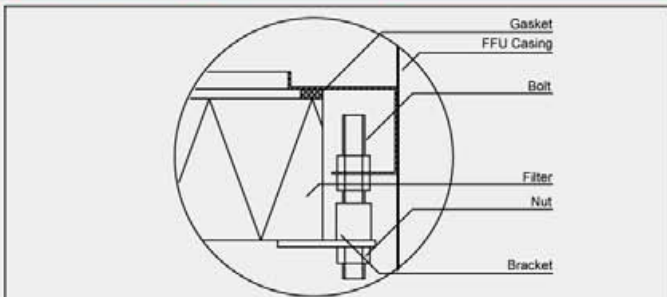

**Pre-filter**

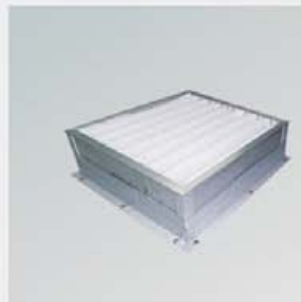

**Adapter for Air Inlet**



**Power Connector**

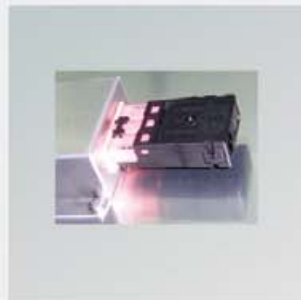

**Indicator (Run/Trip)**



**Manual Controller**



**Cable and Plug**



**Pressure Gauge**



**Diffuser**

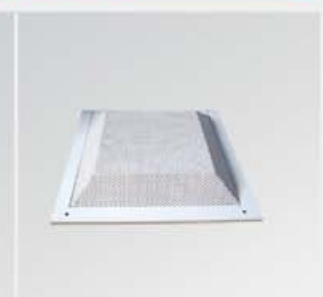

# Fan Filter Unit Group Control Systems

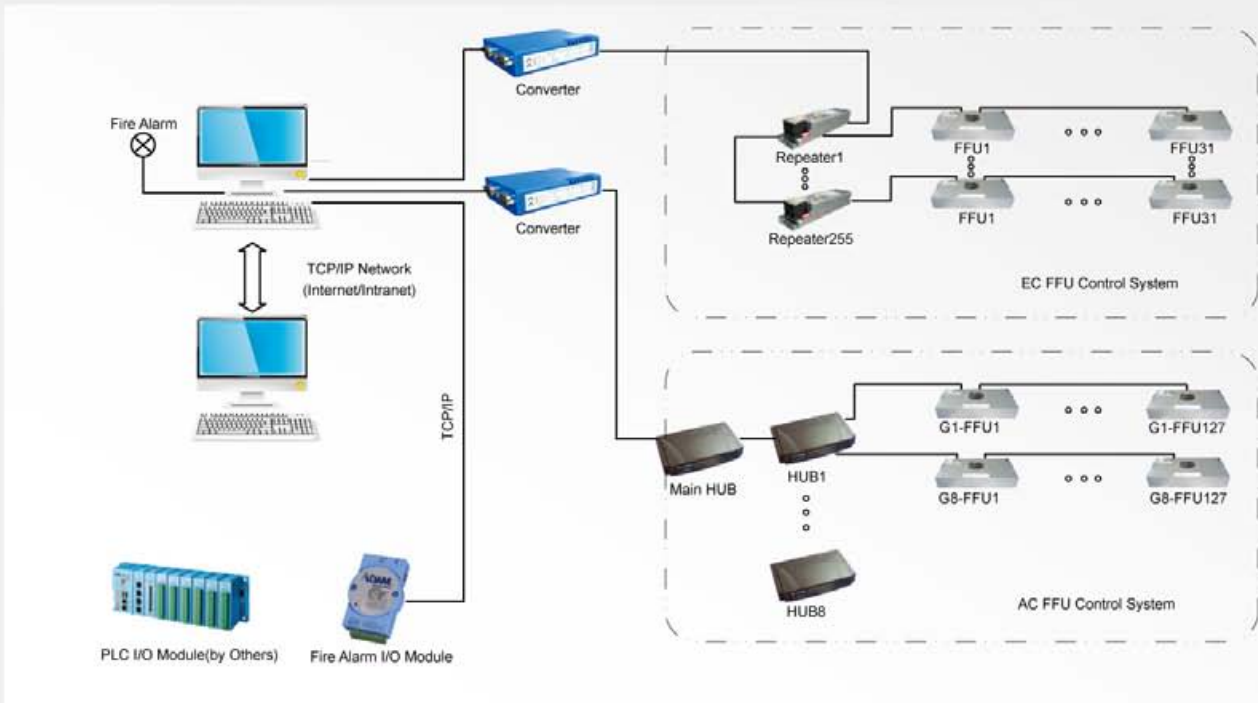

## MayAir Group Control System Features

- All functions of FFU in different buildings, floors or rooms can be controlled remotely from the central computer.
- RS-485 communication mode-integrated hardware, low costs and convenient to install.
- Programmable time scheduler for the automated control of the speed of single or groups of FFU.
- System can be linked with user's existing fire detection network, allowing it to turn off any nearby FFU in the case of fire.
- Power surges prevented by in built automatic group delay start-up system.
- FFU runs with the last command if the cable is disconnected.
- Four-level password management system.

## EC Control System Features

- EC system can control 255 groups, 31units per group, total 7905 units.
- Automatic diagnostic error message and unit location for easy maintenance.

## AC Control System Features

- AC system can control 64 groups, 127 units per group, total 8128 units.
- Safe and reliable for the overload current limits set.

## Touch Screen Computer Control System Features

- Convenient to control and monitor the FFU through the touch screen computer.
- Save space and the cost, suitable for small-group FFU control.

## Focused

In our mission and grows from strength to strength  
with our customers



# MayAir International Group of Companies

---

MayAir International Sdn. Bhd.  
MayAir (S.E.A) Sdn. Bhd.  
MayAir Manufacturing (M) Sdn. Bhd.  
MayAir R&D Centre Sdn. Bhd.  
MayAir Technology (Nanjing) Co., Ltd.  
MayAir Air Filtration Equipment (Nanjing) Co., Ltd.  
MayAir Technology (Shanghai) Co., Ltd.  
MayAir Technology (Zhongshan) Co., Ltd.

## MayAir International

---

Address: No. 59, Shuntai Street, Jiangning  
Economic Development Zone, Nanjing,  
Jiangsu Province, 211100 P. R. China  
Tel: +86 25 5212 4676  
Fax: +86 25 5212 4055  
E-mail: [enquiry@mayair.com.cn](mailto:enquiry@mayair.com.cn)  
Website: [www.mayairgroup.com](http://www.mayairgroup.com)

---



MayAir has a policy of continuous product development and improvement  
and reserves the right to change design and specifications without prior notice.

**PB-FFU-EN-2010A**